



## Domestic Air conditioner

### CAUTION

1. READ THIS MANUAL CAREFULLY TO  
DIAGNOSE TROUBLE CORRECTLY  
BEFORE OFFERING SERVICE.
2. THIS MANUAL IS USED BY QUALIFIED  
APPLIANCE TECHNICIANS ONLY.
3. HAIER DOES NOT ASSUME ANY  
RESPONSIBILITY FOR PROPERTY  
DAMAGE OR PERSONAL INJURY FOR  
IMPROPER  
SERVICE PROCEDURES DONE BY ONE  
UNQUALIFIED PERSON.



# ***TECHNICAL DATA***

## **ON/OFF**

### Wall mounted Type ARC-Series

HSU-18LE03  
HSU-22LE03



**Большая библиотека технической документации**

<https://splitsystema48.ru/instrukcii-po-ekspluatácii-kondicionerov.html>

**каталоги, инструкции, сервисные мануалы, схемы.**

# Table of Contents

<b>1. Features</b> .....	2
<b>2. Specifications</b> .....	3
<b>3. Remote controller lists</b> .....	6
<b>4. Sensors lists</b> .....	6
<b>5. Dimensional drawings</b> .....	7
<b>6. Operation range</b> .....	9
<b>7. Piping diagrams</b> .....	10
<b>8. Wiring diagrams</b> .....	11
<b>9. Capacity diagrams and curves diagrams</b> .....	13
<b>10. Sound level</b> .....	15
<b>11. Accessories</b> .....	16
<b>12. Control systems</b> .....	17
<b>13. Center of gravity</b> .....	19
<b>14. Installations</b> .....	20

# 1 Features



Auto mode: According to the fixed temperature "26°C", the unit will adjust the operation mode automatically.



Sleep mode: The setting temperature and the indoor noise can be adjusted to a more comfortable level when you set the "sleep mode" during night sleep .



Easy clean design: The panel is easy to wash and the airflow vents can be detached without any special tools for quick cleaning of the inside of the air conditioner .



24 Hour timer: Use the timer function to set on, or off, or from on to off, or from off to on .



Auto restart: The function permits automatic return to previous operation conditions after a sudden power blackout .



DRY function: Make dehumidifying in the room when the unit is working in the "DRY" mode .



Healthy negative ion: make your room full of an abundance natural negative ions.



## 2.Specifications

This information was not available at the time of publication

NOMINAL CAPACITY and NOMINAL INPUT					
Model				HSU-18LE03	HSU-22LE03
NOMINAL CAPACITY(3-4)	Cooling(1)	norm.	kw	5.00	6.20
	Heating(2)	norm.	kw	-----	-----
NOMINAL INPUT	Cooling	norm.	kw	1.90	2.35
	Heating	norm.	kw	-----	-----
EER	Cooling			2.63	2.64
COP	Heating			-----	-----
ENERGY LABEL(7-8)	Cooling			----	----
	Heating			----	----
ANNUAL ENERGY CONSUMPTION(9)	Cooling		kwh	795	970

TECHNICAL SPECIFICATIONS						
INDOOR UNITS				HSU-18LE03	HSU-22LE03	
DIMENSIONS	Unit	H	mm	265		
		W	mm	938		
		D	mm	182		
WEIGHT	Unit	kg		11		
COLOR	Unit	white				
SOUND LEVEL	Sound pressure (cooling/heating)(5)	high	dB(A)	45	48	
		medium	dB(A)	43	45	
		low	dB(A)	40	39	
	Sound power(cooling/heating)(6)	high	dB(A)	45	48	
FAN	Air flow rate(cooling/heating)	high	m <sup>3</sup> /min	11.0	11.5	
		low	m <sup>3</sup> /min	10.3	10.0	
		super low	m <sup>3</sup> /min	9.2	9.8	
	Speed(cooling/heating)	steps		5steps,silent and auto		
		high	rpm	1350	1350	
		medium	rpm	1250	1250	
		low	rpm	1150	1100	
Type	Cross flow fan					
Motor output	W		16	16		
AIR FILTER	Removable/washable/mildew proof					
REMOTE CONTROLLER	YL-M07EN					
TEMPERATURE CONTROL	Microcomputer control					
PIPING CONNECTIONS(external diameter)	liquid	mm	Φ 6.35	Φ 6.35		
	gas	mm	Φ 12.7	Φ 15.88		
	drain	mm	Φ 16	Φ 16		
INSULATION MATERIAL	Heat insulation type			both liquid and gas pipes		
HEAT EXCHANGGER	TYPE		ML fin - Φ 9.52HI - XA tube			
	Row x stage x fin pinth		mm	2 x 8 x1.4		

TECHNICAL SPECIFICATIONS					
OUTDOOR UNITS			HSU-18LE03	HSU-22LE03	
NET DIMENSIONS (stop valve, and bottom support is not included)	Unit	H	mm	540	632
		W	mm	780	780
		D	mm	245	257
WEIGHT	Unit		kg	34	45
COLOR	Unit	white			
SOUND LEVEL	Sound pressure(cooling/heating)(5)	high	dB(A)	58	60
	Sound power(cooling/heating)(6)	high	dB(A)	58	60
FAN	Air flow rate(cooling/heating)	high	m <sup>3</sup> /min	25	30
		low	m <sup>3</sup> /min	-----	----
	Speed(cooling/heating)	high	rpm	880	860
		low	rpm	---	---
	Type	Propeller fan			
	Motor output		W	80	80
REFRIGERANT CIRCUIT	Refrigerant type	R22			
	Refrigerant charge		kg	0.955	1.40
	Maximum allowable distance between indoor and outdoor		m	15	
	Maximum allowable level difference		m	5	
	Refrigerant control	-----			
COMPRESSOR	Type	rotary Compressor			
	Model			48R473AQ-51S	55R613A
	Motor output		w	1800	2100
	Oil type			SUNISO 4GSI	SUNISO 4GSI
	Oil charge volume		L	0.27	0.52
PIPING CONNECTIONS	liquid		mm	Φ 6.35	
	gas		mm	Φ 12.7/Φ15.88	
	drain		mm	Φ 18	
INSULATION MATERIAL	Heat insulation type			both liquid and gas pipes	
HEAT EXCHANGGER	TYPE				ML - Φ9.52HI - XAbube
	Row x stage x fin pinth		mm	2 x 8 x1.4	

ELECTRICAL SPECIFICATIONS					
For indoor units only:				HSU-18LE03	HSU-22LE03
CURRENT	Nominal running current	cooling	A	0.15	0.15
		heating	A	-----	-----
	Maximum running current	cooling	A	0.15	0.15
		heating	A	-----	-----

For combination indoor units+ outdoor units:				HSU-18LE03	HSU-22LE03
CURRENT	Nominal running current	cooling	A	8.9	11.3
		heating	A	-----	-----
	Maximum running current	cooling	A	12.9	12.6
		heating	A	-----	-----
	Starting current	cooling	A	30	42
		heating	A	-----	-----

For indoor units only:			HSU-18LE03	HSU-22LE03
POWER SUPPLY			VM	VM
NOMINAL DISTRIBUTION SYSTEM VOLTAGE	Phase		1PH	1PH
	Frequency	Hz	50	50
	Voltage	V	220V~	220V~

## NOTES

- 1 Nominal cooling capacities are based on: indoor temperature 27°CDB/19°CWB \* outdoor temperature 35°CDB \* refrigerant piping length: 5m \* level difference: 0m.
- 2 Nominal heating capacities are based on: indoor temperature 20°CDB \* outdoor temperature 7°CDB/6°CWB \* refrigerant piping length 5m (horizontal) \* level difference 0m.
- 3 Capacities are net, including a deduction for cooling (an addition for heating) for indoor fan motor heat.
- 4 Units should be selected on nominal capacity. Maximum capacity is limited to peak periods.
- 5 The sound pressure level is measured via a microphone at a certain distance from the unit. For measuring conditions: please refer to item 6 of this chapter.
- 6 The sound power level is an absolute value indicating the "power" which a sound source generates.
- 7 Energy label: scale from A (most efficient) to G (less efficient).
- 8 The energy label Directive 2002/31/EC will enter into force once the relevant measurement standard will be published in the European official Standard.
- 9 Annual energy consumption: based on average use of 500 running hours per year at full load (= nominal conditions)

### 3 Remote controller lists

Model	HSU-18LE03	HSU-22LE03
YL-M07	Y	Y
YL-H10	Y	Y

### 4 Sensors lists

INDOOR UNIT		
type	Description	Qty
Room sensor	It's used for detecting room temperature	1
Pipe sensor	It's used for detecting temperature of evaporator	1

## 5 Dimensional drawings

### Indoor unit

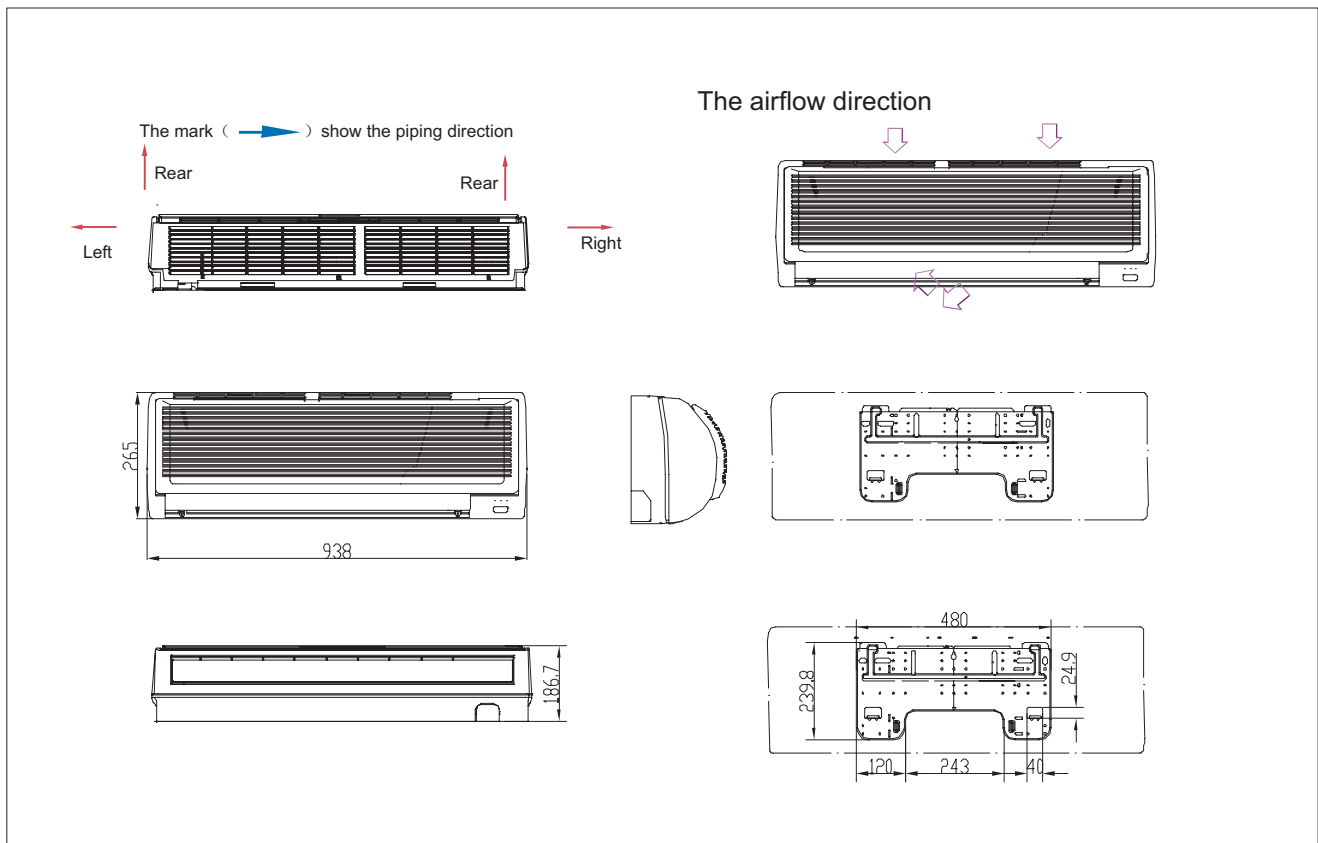



Outdoor unit

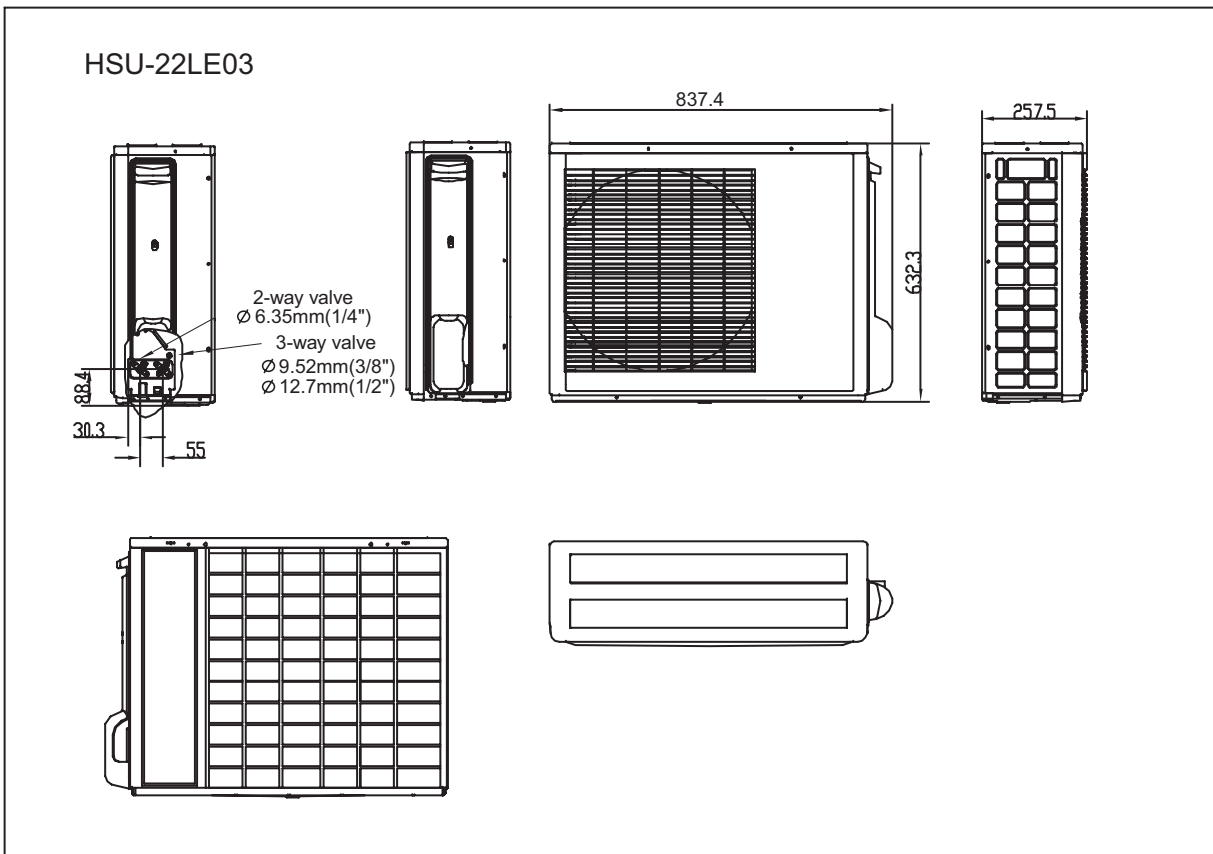
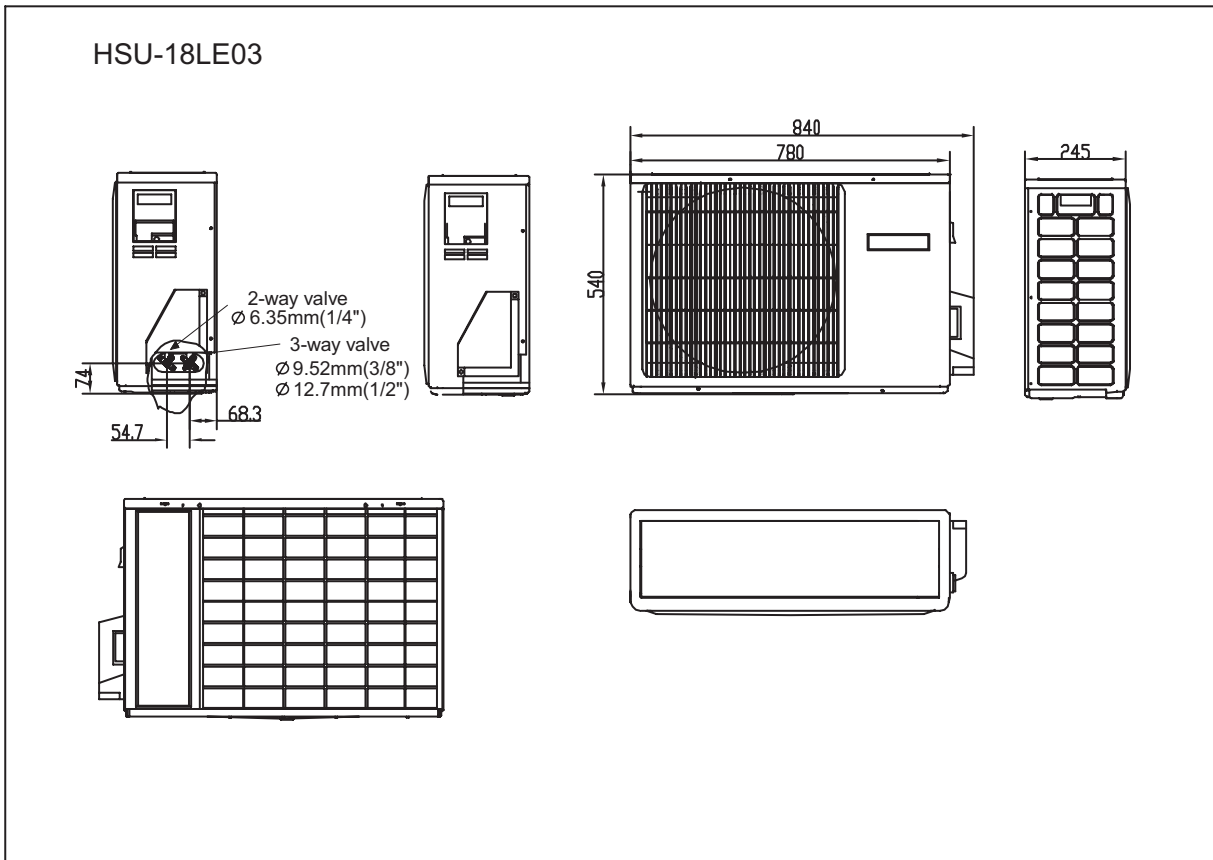

# 6 Operation range

The name of parts

Cooling

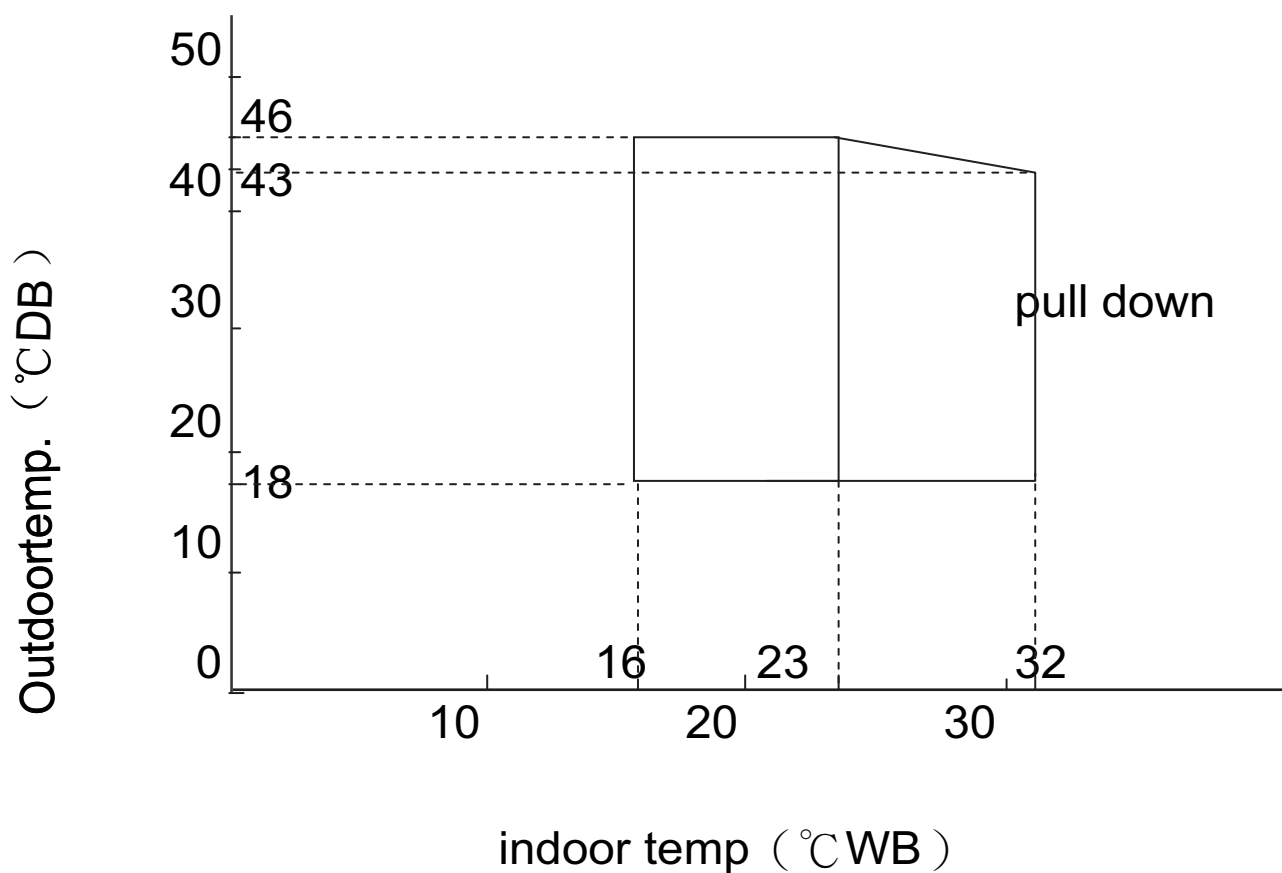

# 7 Piping diagrams

## Cooling mode

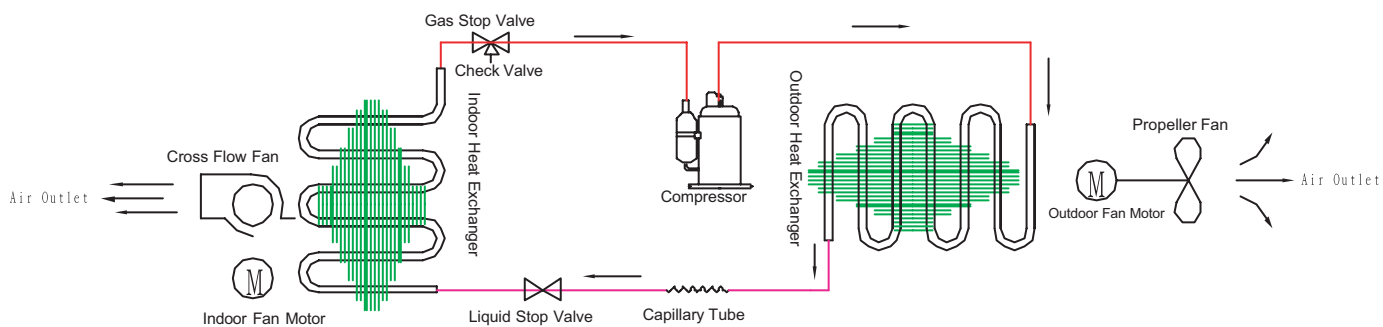

# 8 Wiring diagrams

## Indoor unit

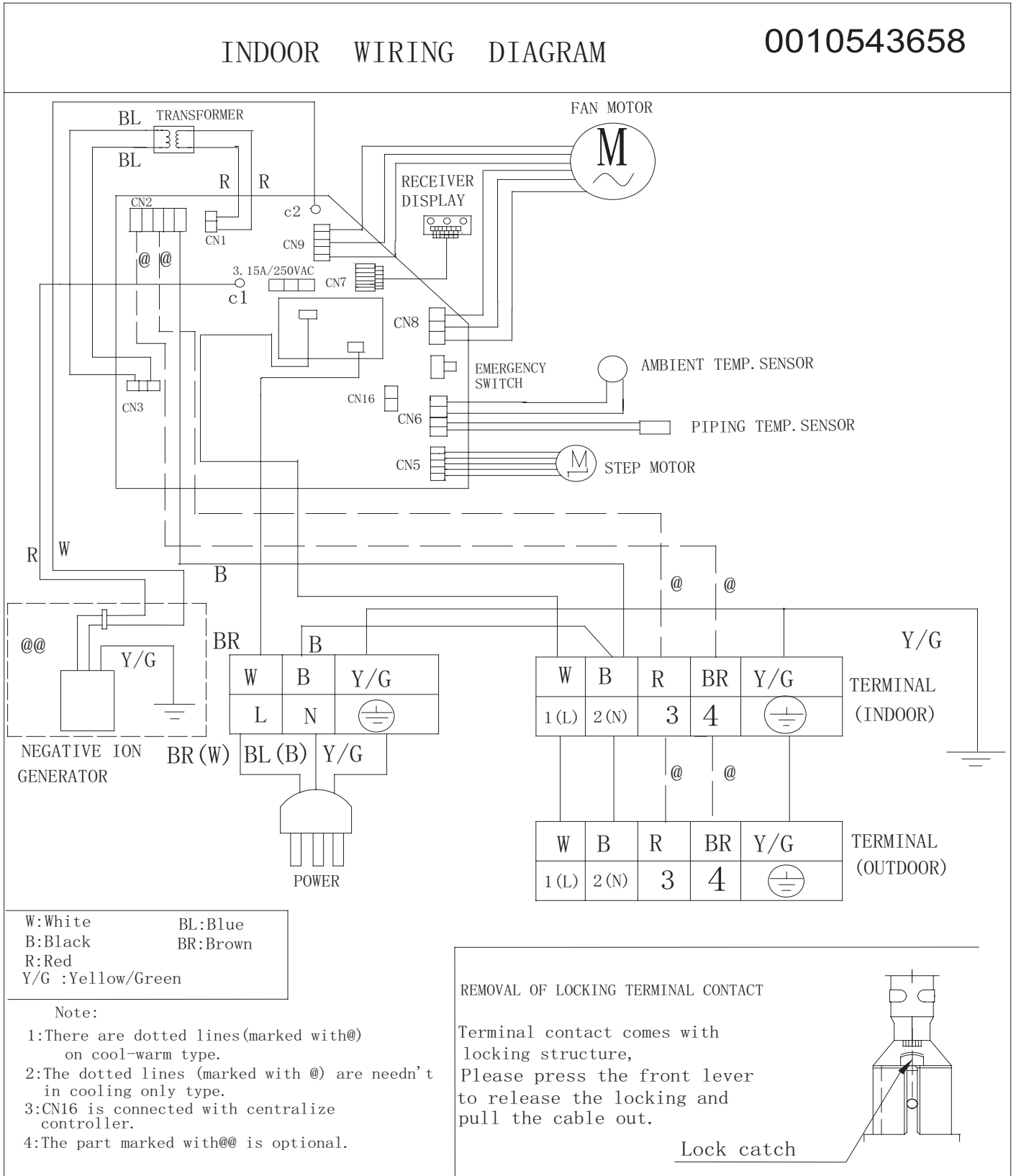

Outdoor unit

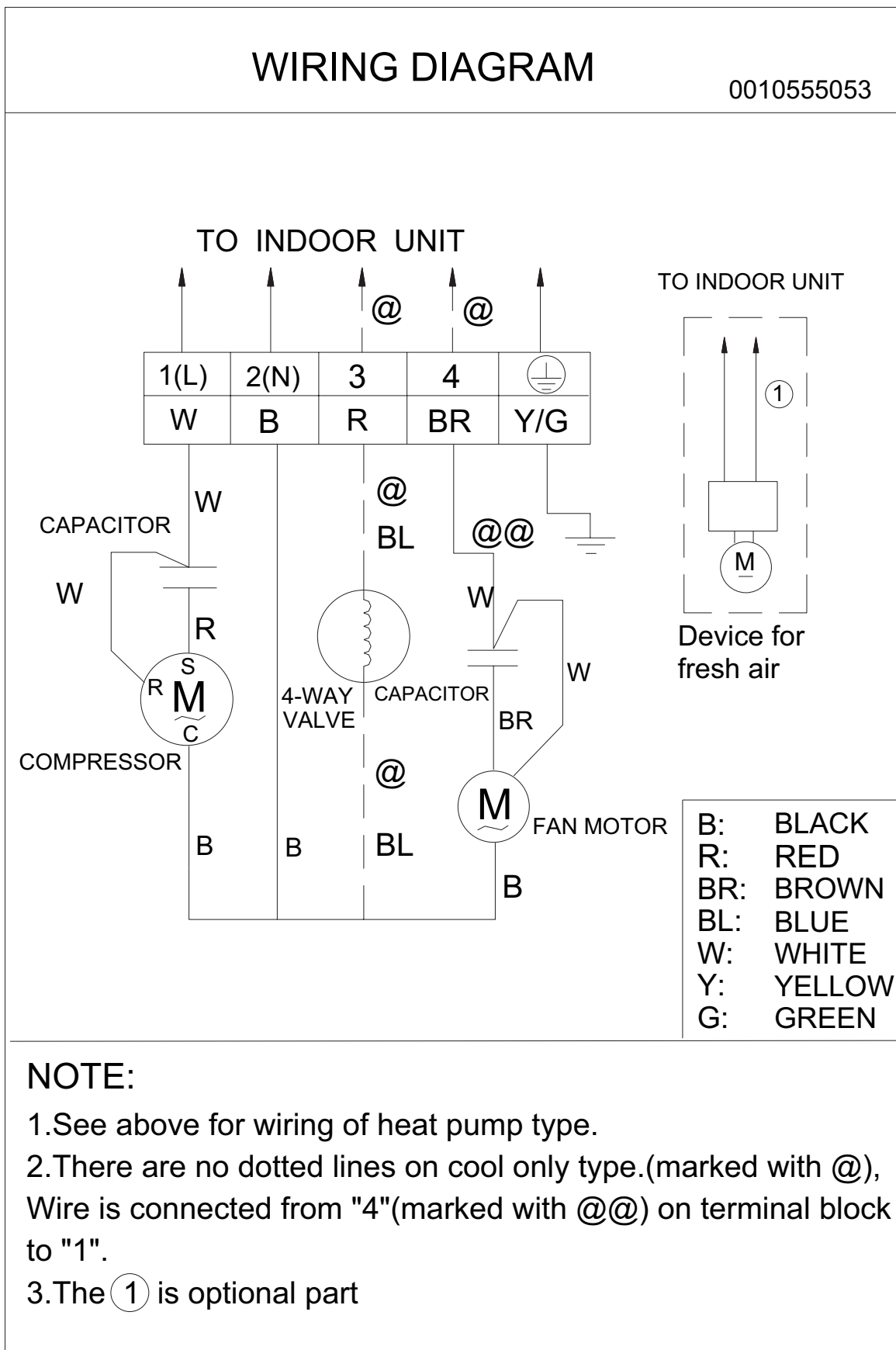

## 9 Capacity tables and curves diagrams

HSU-18LE03 performance curves								
cooling value-temperature talbe								
indoor temp	outdoor temp.(humidity 46%)							
DB/WB	18°C	20°C	25°C	32°C	35°C	40°C	43°C	46°C
18/12°C	4186	4197	4207	3986	3996	4039	3889	3673
18/14°C	4669	4680	4747	4495	4458	4328	4216	4030
20/15°C	5151	5164	5177	5082	4920	4759	4623	4387
22/16°C	5097	5113	5130	5062	4887	4681	4542	4377
25/18°C	5044	5063	5082	5041	4854	4668	4545	4349
27/19°C	5305	5215	5265	5102	5000	4849	4726	4502
30/22°C	5582	5434	5622	5328	5198	5068	4896	4749
32/23°C	5682	5418	5628	5299	5242	5133	5005	4777
32/24°C	5761	5492	5706	5371	5313	5201	5070	4840

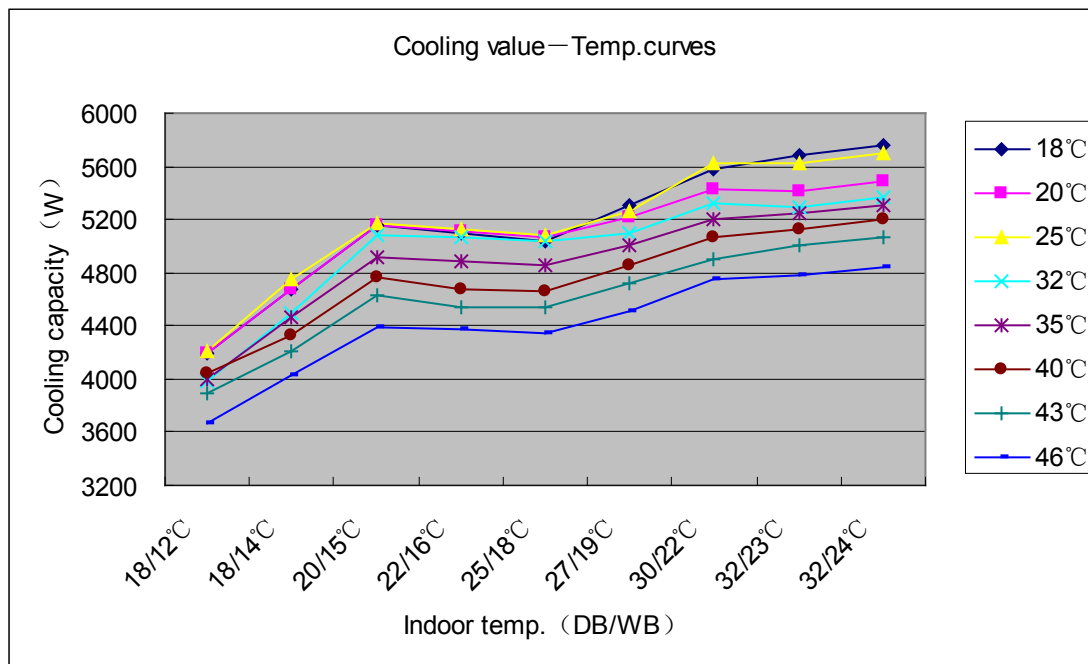

HSU-22LE03 performance curves								
cooling value-temperature talbe								
indoor temp	outdoor temp.(humidity 46%)							
DB/WB	18°C	20°C	25°C	32°C	35°C	40°C	43°C	46°C
18/12°C	5386	5397	5407	5186	5196	5239	5089	4873
18/14°C	5869	5880	5947	5695	5658	5528	5416	5230
20/15°C	6351	6364	6377	6282	6120	5959	5823	5587
22/16°C	6297	6313	6330	6262	6087	5881	5742	5577
25/18°C	6244	6263	6282	6241	6054	5868	5745	5549
27/19°C	6505	6415	6465	6302	6200	6049	5926	5702
30/22°C	6782	6634	6822	6528	6398	6268	6096	5949
32/23°C	6882	6618	6828	6499	6442	6333	6205	5977
32/24°C	6961	6692	6906	6571	6513	6401	6270	6040

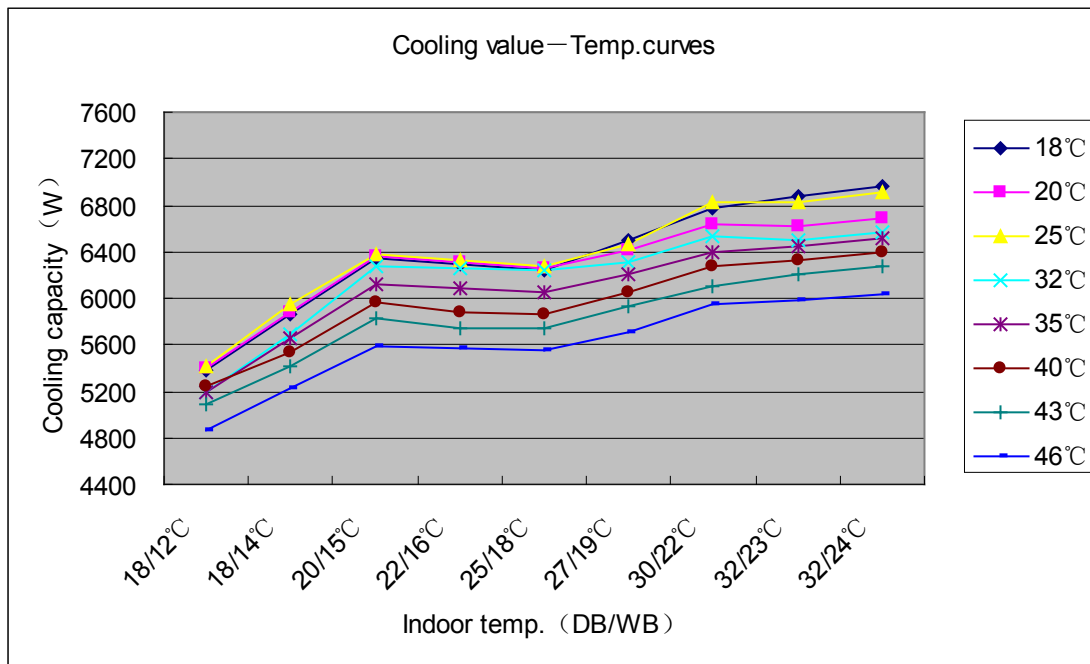

# 10 Sound level

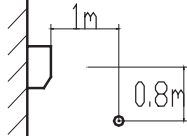
Model	Sound pressure level			Measuring location Location of microphone 	sound power level
	220 ~ V,50Hz				
	Cooling				
	H	L	SL		
HSU-18LE03	45	43	40		45
HSU-22LE03	48	45	39		48

## Sound level data

HSU-18LE03	100Hz	125Hz	250Hz	500Hz	1000Hz	2000Hz	4000Hz	6000Hz	8000Hz
INDOOR	47.7	39.7	38.6	41.6	34.5	31.2	23.7	0.0	0.0
OUTDOOR	58.7	52.5	49.2	47.6	47.9	43.7	38.0	34.9	33.9

HSU-22LE03	100Hz	125Hz	250Hz	500Hz	1000Hz	2000Hz	4000Hz	6000Hz	8000Hz
INDOOR	41.7	34.7	33.6	39.6	30.5	28.2	19.7	0.0	0.0
OUTDOOR	61.4	56.7	56.7	53.9	51.8	47.8	41.7	39.7	35.6

## Sound pressure spectrum



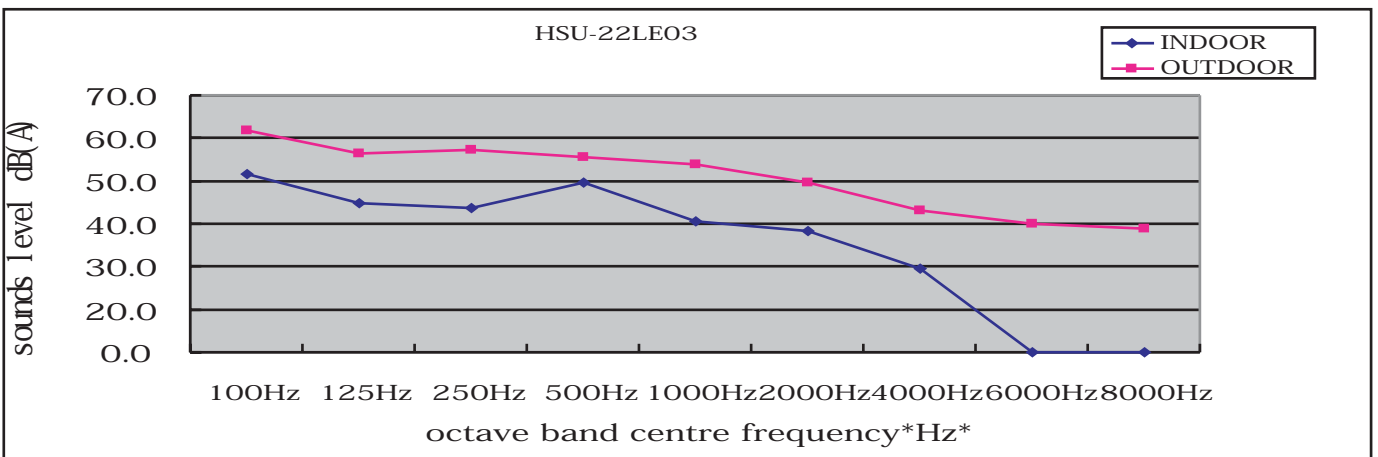
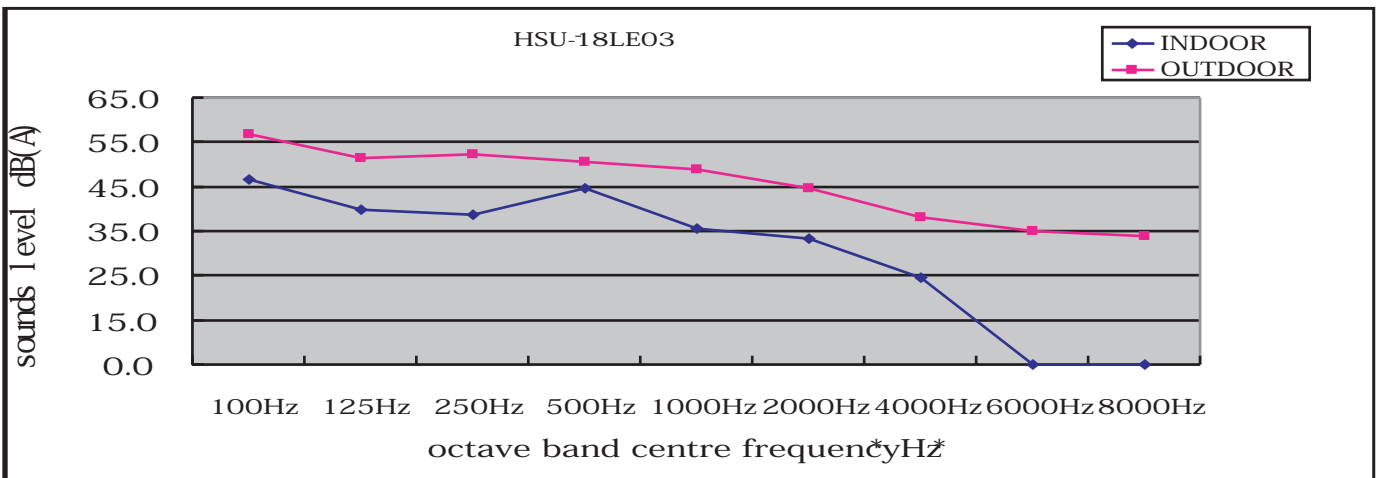

# 11 Accessories

## Standard accessories

Standard name	HSU-18LE03	HSU-22LE03
Drain hose	1	1
Plastic bag	1	1
screw assembly	1	1
Air purifier	2	2
Battery	2	2
Mounting plate	1	1
Remote controller	1	1
Installation manual	1	1
Operation manual	1	1

## 12 Control systems

### Operation

Buttons and display of the remote controller.

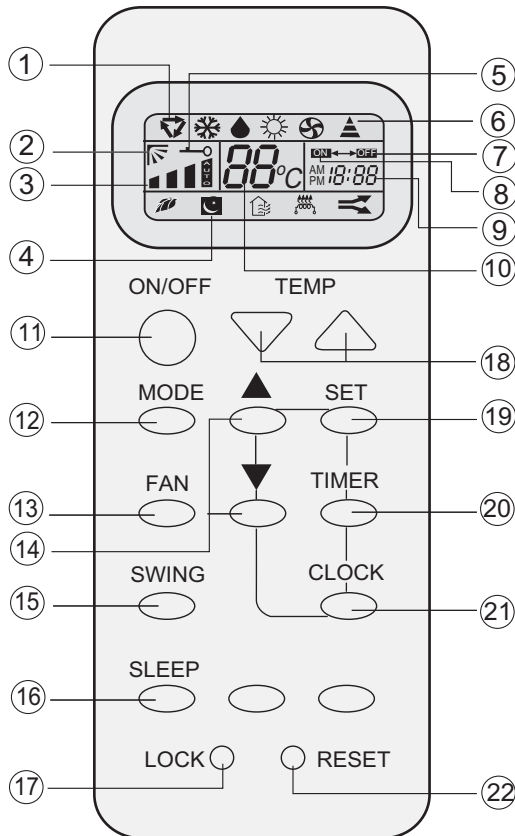

#### 1. Mode display

AUTO   
 COOL   
 DRY   
 HEAT   
 FAN 

#### 2. SWING display



#### 3. FAN SPEED display

#### 4. SLEEP display

#### 5. LOCK display

#### 6. SIGNAL SENDING

#### 7. TIMER OFF display

#### 8. TIMER ON display

#### 9. CLOCK display

#### 10. TEMP display

#### 11. POWER ON/OFF

Used for unit start and stop.

#### 12. MODE

Used to select AUTO run, COOL, DRY, HEAT and FAN operation

#### 13. FAN

Used to select fan speed LO, MED, HI, AUTO

#### 14. HOUR

Used to set clock and timer setting.

#### 15. SWING

Used to set auto fan direction.

#### 16. SLEEP

Used to select sleep mode.

#### 17. LOCK

Used to lock buttons and LCD display.

#### 18. TEMP.

Used to select your desired temp.

#### 19. SET

Used to confirm timer and clock settings.

#### 20. TIMER

Used to select TIMER ON, TIMER OFF, TIMER ON-OFF

#### 21. CLOCK

Used to set correct time

#### 22. RESET

Used to reset the controller back to normal condition.

### Clock set

When unit is started for the first time and after replacing batteries in remote controller, clock should be adjusted as follows:

Press CLOCK button, "AM" or "PM" flashes.

Press  $\Delta$  or  $\nabla$  to set correct time. Each press will increase or decrease 1min. If the button is kept depressed, time will change quickly.

After time setting is confirmed, press SET, "AM" and "PM" stop flashing, while clock starts working.

NOTE: Cooling only unit do not have displays and functions related with heating

### Hints





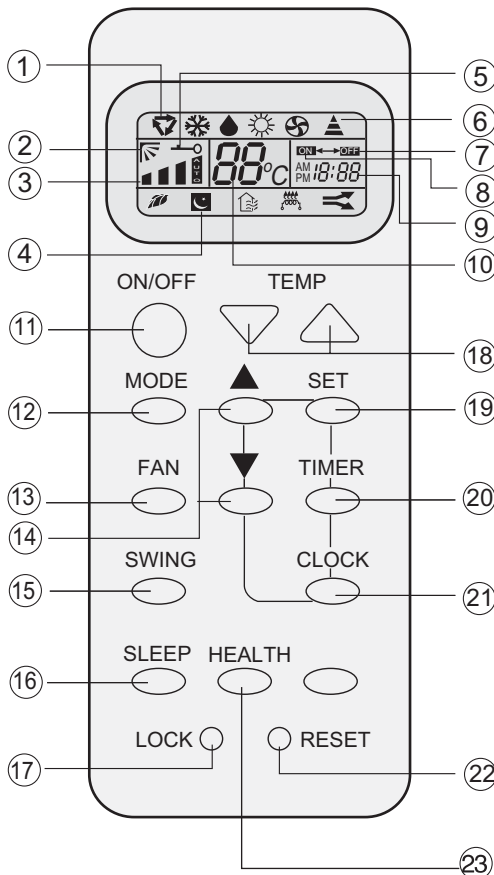

After replacing with new batteries, remote controller will conduct self-check, displaying all information on LCD. Then, it will become normal.

## Operation

### Buttons and display of the remote controller.

If the unit which you purchased has healthy function, Remote controller should like the following figure:

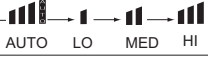

1. Mode display  
 AUTO   
 COOL   
 DRY   
 HEAT   
 FAN 
2. SWING display 
3. FAN SPEED display 
4. SLEEP display
5. LOCK display
6. SIGNAL SENDING
7. TIMER OFF display
8. TIMER ON display
9. CLOCK display
10. TEMP display
11. POWER ON/OFF  
Used for unit start and stop.
12. MODE  
Used to select AUTO run, COOL, DRY, HEAT and FAN operation
13. FAN  
Used to select fan speed LO, MED, HI, AUTO
14. HOUR  
Used to set clock and timer setting.
15. SWING  
Used to set auto fan direction.
16. SLEEP  
Used to select sleep mode.
17. LOCK  
Used to lock buttons and LCD display.
18. TEMP.  
Used to select your desired temp.
19. SET  
Used to confirm timer and clock settings.
20. TIMER  
Used to select TIMER ON, TIMER OFF, TIMER ON-OFF
21. CLOCK  
Used to set correct time
22. RESET  
Used to reset the controller back to normal condition.
23. HEALTH  
Used to set healthy operation

#### BRIEF INTRODUCTION TO HEALTH OPERATION

The anion generator in the air conditioner can generate a lot of anion to effectively balance the quantity of positive and negative ions in the air and also to kill bacteria and speed up the dust sediment in the room and finally clean the air in the room.

NOTE: Cooling only unit do not have displays and functions related with heating

#### Hints

After replacing with new batteries, remote controller will conduct self-check, displaying all information on LCD. Then, it will become normal.

# 13 Center of gravity

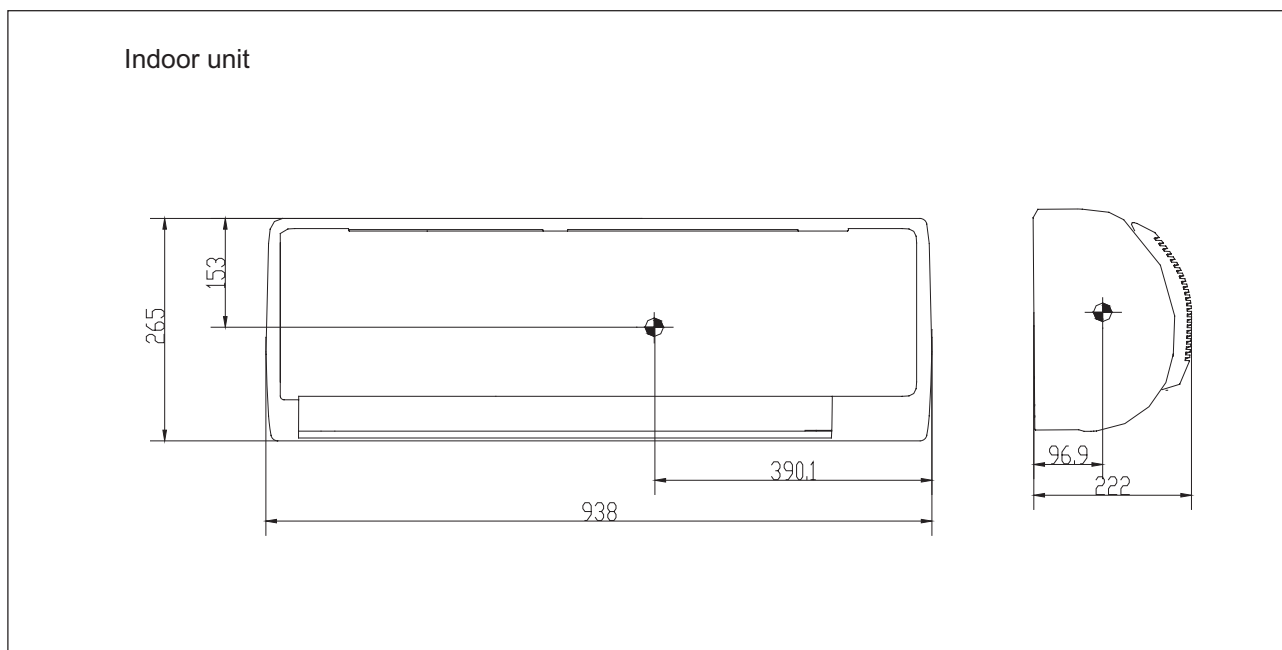

HSU-18LE03

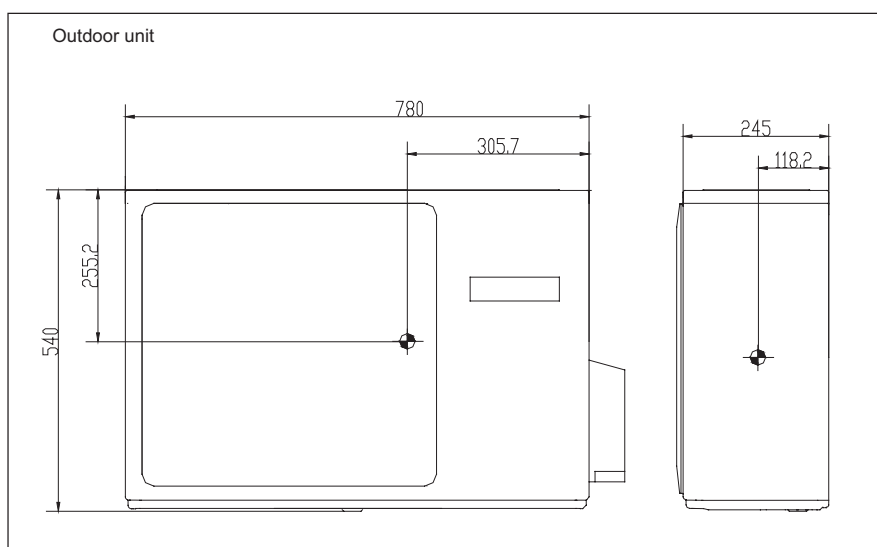

HSU-22LE03

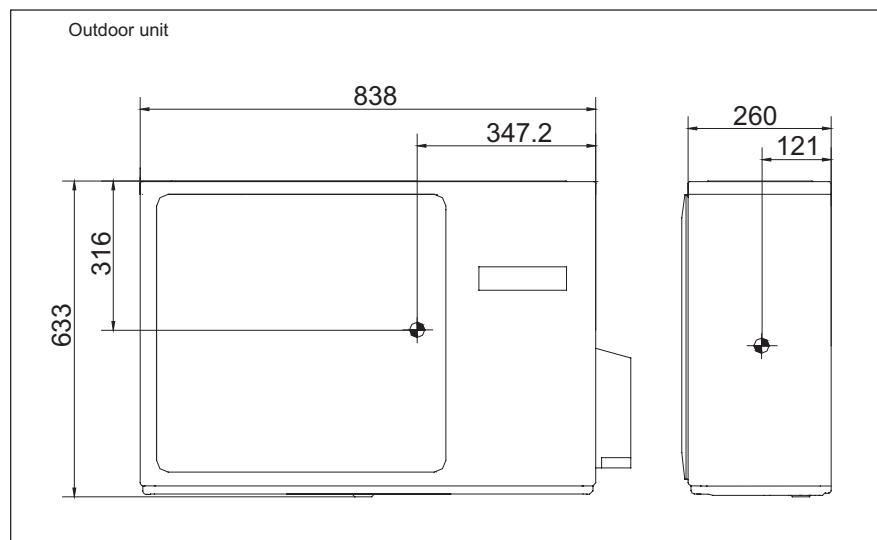

# 14 Installations

## Indoor unit installation drawings

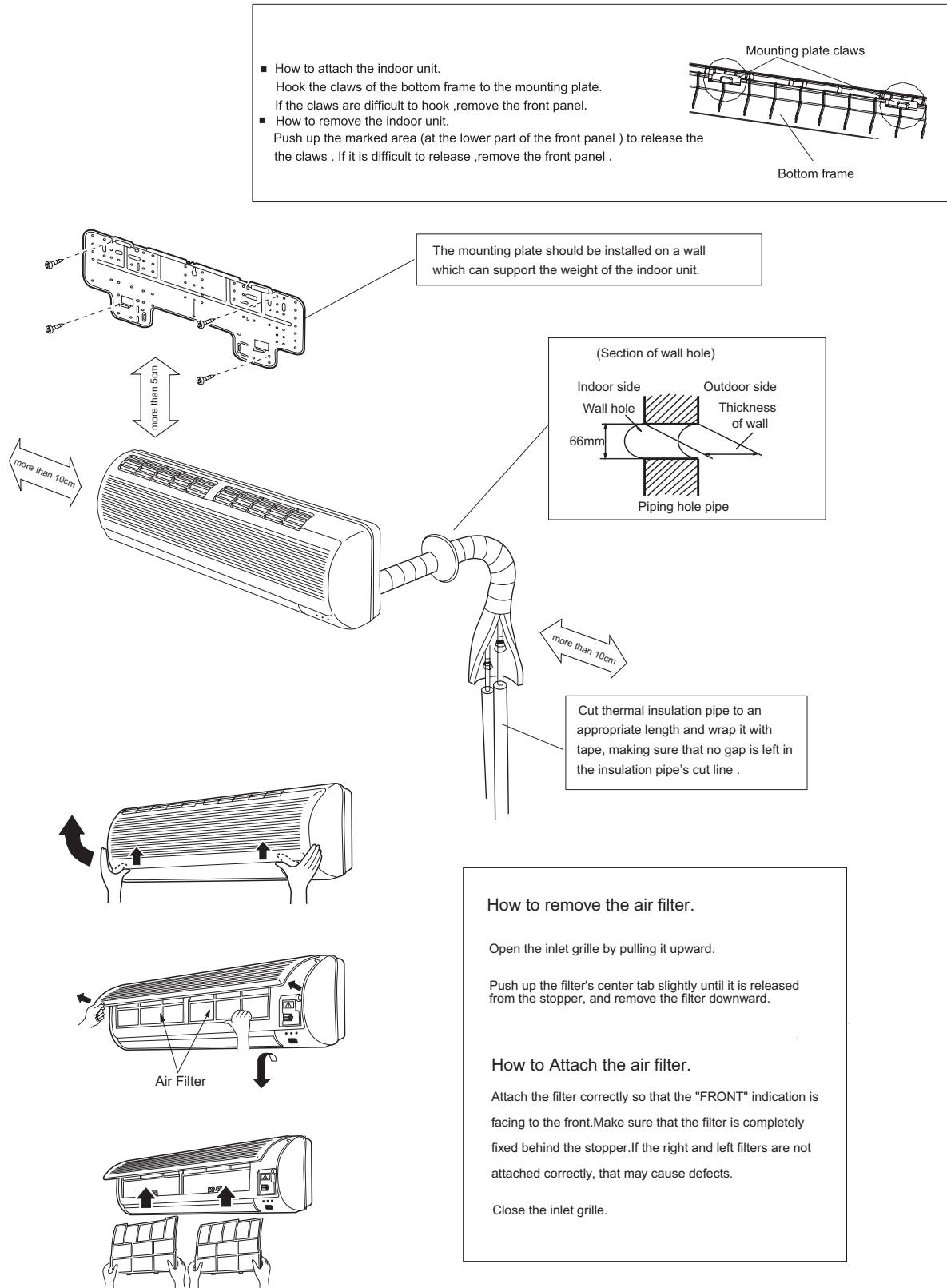

# Outdoor unit installation drawings

## HSU-18,22LE03

### Outdoor

Model	26/28 class
Max.allowable length	Cooling only: 15m Heat pump: 15m
Max.allowable height	5m
Additional refrigerant required for refrigerant pipe exceeding 5m in length	16g/m
Gas pipe	O. D. 6.35/12.7
Liquid pipe	O. D. 6.35/15.88

\*Be sure to add the proper amount of additional refrigerant. Failure to do so may result in reduced performance.

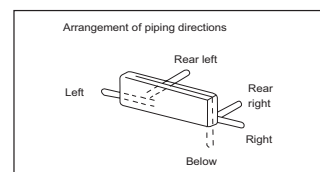

The distance between the indoor unit and the floor should be more than 2m.

Wrap the installation pipe with the finishing tape from bottom to top Model 25 / 35 class

**Service lid**

- How to remove the service lid. This service lid is an open/close type. Slide the lid downward to remove it.
- How to attach the service lid. Insert the upper part of the service lid into the outdoor unit to install. Tighten the screws.

Where there is a danger of the unit falling, use foot bolts, or wires.

- Fix the unit to concrete or block with bolts (φ10mm) and nuts firmly and horizontally.
- When fitting the unit to wall surface, roof or rooftop, fix a supporter surely with nails or wires in consideration of earthquake and strong wind.
- If vibration may affect the house, fix the unit by attaching a vibration-proof mat.

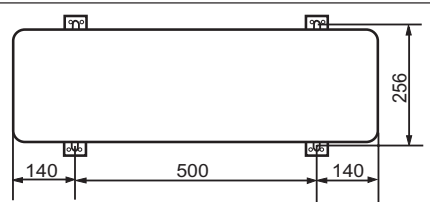

# Sincere Forever



Haier Group

---

Haier Industrial Park, No.1, Haier Road  
266101, Qingdao, China

E-mail: [hractech@haier.com](mailto:hractech@haier.com)

Tel: +86 532 87636957

[Http://www.haier.com](http://www.haier.com)

Edited by: Zhao Jicheng

Signed by: Yang Bifei

Approved by: Zhu Zhenxue